

PDF Standards

Angiah Santhanaswamy
Head - Government Solution (India & SAARC)



Overview

- Why the need for standards?
- A detailed look at PDF
- What are the PDF standards?
- Related standards
- How standards help you
- Resources

We Live in a Standards-Based World...or do we?



SYSTEM		SIZES															
Europe		35	35½	36	37	37½	38	38½	39	40	41	42	43	44	45	46½	48½
Mexico							4.5	5	5.5	6	6.5	7	7.5	9	10	11	12.5
Japan	M	21.5	22	22.5	23	23.5	24	24.5	25	25.5	26	26.5	27.5	28.5	29.5	30.5	31.5
	W	21	21.5	22	22.5	23	23.5	24	24.5	25	25.5	26	27	28	29	30	31
U.K.	M	3	3½	4	4½	5	5½	6	6½	7	7½	8	8½	10	11	12	13½
	W	2½	3	3½	4	4½	5	5½	6	6½	7	7½	8	9½	10½	11½	13
Australia	M	3	3½	4	4½	5	5½	6	6½	7	7½	8	8½	10	11	12	13½
	W	3½	4	4½	5	5½	6	6½	7	7½	8	8½	9	10½	11½	12½	14
U.S. & Canada	M	3½	4	4½	5	5½											
	W	5	5½	6	6½	7											
Russia & Ukraine	W	33½	34		35												
Korea (mm)		228	231	235	238	241											
Inches		9	9⅛	9¼	9⅜	9½											
Centimeters		22.8	23.1	23.5	23.8	24.1											
Mondopoint		228	231	235	238	241											



Electronic Format Standards

- Guidelines or requirements for how information is to be submitted electronically for official review, record keeping or archiving
- Defines the file format, form or process
 - De-facto: widely used, may be proprietary, may be published
 - .DOC
 - De-jure: developed/maintained by a working group - these are generally open standards
 - ODF, PDF/A, STEP
 - Mandated: usually by governments, sometimes by industry (e.g., supply chains)
- Developed by standards groups, private industry associations, common interest groups, or individual companies

Standards Benefit Business and Government

- Facilitate interoperability
- Streamline regulatory compliance
- Align software development with industry need
- Raise quality, reliability, efficiency levels
- Help provide access to all



Worldwide Government PDF Installations

- Electronic document exchange/forms/filings
- Archiving of forms, records, decisions
- Publication of legislative activities/handbooks/ agricultural data/reports
- Examples:
 - IRS – USA
 - Federal Courts – USA
 - SAC (China) – PDF/A is a national standard
 - Federal Police – Germany
 - Ministry of Justice – Japan
 - National Archives – Sweden, Victoria (Australia)
 - Army Corps of Engineers – USA



PDF – the “Digital Envelope” for all your content

- A comprehensive format for representing documents and forms
- **Solid Core Features**
 - High fidelity, high precision text layout with embeddable fonts
 - High-end device independent, color managed graphics features
 - Layered content model with associated rich semantic s
 - Security & digital signatures
 - Platform independent definition
- **Features for Interactive Documents**
 - Document and Collection navigation elements
 - Framework for commenting, markup and collaboration
 - Interactive forms with integrated business logic
 - Multimedia
 - 3D

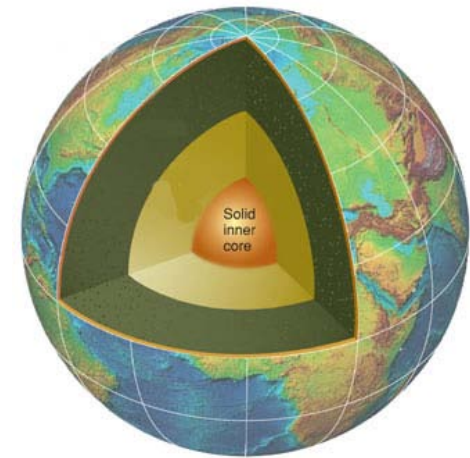

PDF
Presentation
precise form and
layout standards

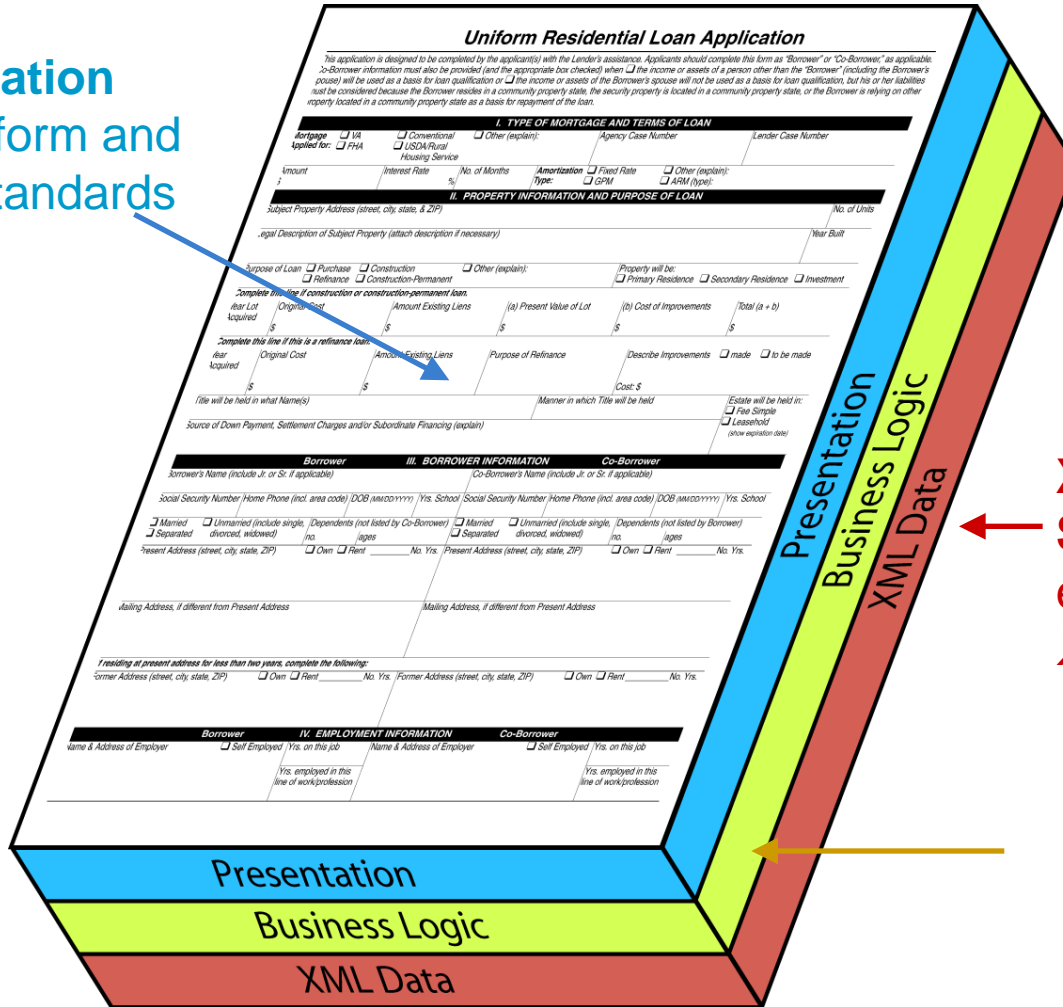

**XML Data
Standards UN
eDocs, RosettaNET,
XBRL**

**View and Data Mapping
and Validation**
calculation, interactive
validation and rendering

Digital Signatures in PDF

- PDF supports both electronic (or wet) signatures as well as digital signatures (based on public key cryptography)
- Digital Signatures can be visible or invisible
- Digital Signatures can be used to approve the document (author's signature) or validate its authenticity (certifying signature)
- PDF Signatures Standardized by ETSI/ES1 as an AdES-conforming signature standard (March 2009).

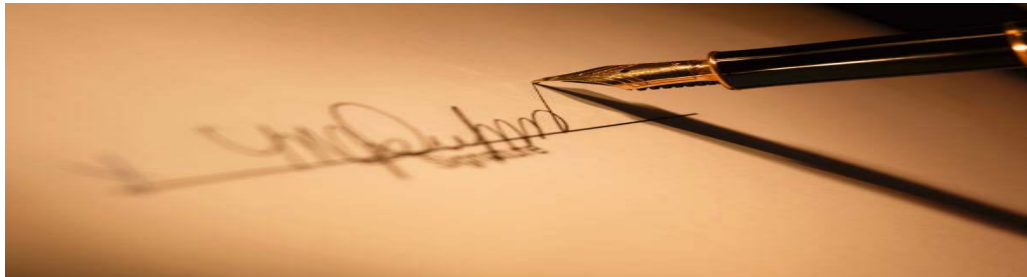

Accessibility

- Specific language features were first added to PDF in 1.4 (Acrobat 5, 2000)
 - Tagged PDF – semantics accompany the content
- Standard API introduced for Adobe Reader to Assistive Technology
 - IPDOM – supported by JAWS, WindowEyes, etc.
- Many features of MSAA based on the work of IPDOM
 - Adobe Reader 8 and later, fully compliant with MSAA
- Adobe introduces Reader features for improved accessibility
 - Read Out Loud
 - Reflow
 - Document Color/Background override



▪ Section 508 Compliant

The Flexibility of PDF

- Gone beyond “electronic paper” to become the “digital envelope”
- PDF can represent more types of data than other formats
- Standards work: create a focused subset of PDF for a specific “use case” or industry requirement
 - PDF/X - Print Publishing
 - PDF/A - Long Term Archiving
 - PDF/E - Engineering (AEC + Building Manufacturing, and Geospatial)
- Provide guidelines for correct viewer behavior to ensure that files are viewed the same whenever & wherever

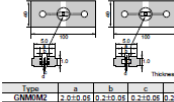
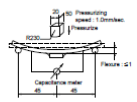
GNN Series Specifications and Test Methods (2)		
No.	Item	Specifications
12	Apertures	No marking defects Within ±10%
	Capacitor Clap	
12	Deflection	
		

Form 1040 Department of the Treasury—Internal Revenue Service **2008**

U.S. Individual Income Tax Return

OMB No. 1545-0047

For the year Jan. 1, Dec. 31, 2008, or other tax year beginning 2008, ending 2008

Use the IRS label, instructions, or page 14 to use the IRS label, instructions, press print or type.

Label
Your first name and initial Last name Your social security number
If a joint return, spouse's first name and initial Last name Spouse's social security number
Home address (number and street). If you have a P.O. box, see page 14. Apt. no.
City, town or post office, state, and ZIP code. If you have a foreign address, see page 14.

Filing Status
 Single
 Married filing jointly (even if only one had income)
 Married filing separately. Enter spouse's SSN above.
 Head of household (with qualifying person). (See page 15.) If the qualifying person is a child but not your dependent, enter this child's name here.
 Qualifying widow(er) with dependent child (see page 16)

Exemptions
 Yourself. If someone can claim you as a dependent, do not check box 6a.
 Spouse.
 Dependents:
 (1) First name Last name (2) Dependent's social security number (3) Dependent's relationship to you
 Total number of exemptions claimed

Income
 Attach Form(s) W-2 here. Also attach Forms W-2S and 1099-R if tax was withheld.
 If you did not get a W-2, see page 21.
 Enclose, but do not attach, any payment. Also, please use Form 1040-V.

Adjusted Gross Income

For Disclosure, Privacy Act, and Paperwork Reduction Act Notice, see page 98.

HEALTH Corporation Implant Matching Form

Thank you for your interest in a new HealthCorp Implant device. The information included in this document details the features we have designed into your patient's implant based on the CT scan and additional information provided to our department. The attached 3D PDF image is designed to visually convey to you these design features and allow you evaluate the options to provide as well any comments, changes, or a final approval of the implant design. Please take a moment to evaluate the model for the following features:

- Anterersion
- Abduction
- Medial/Lateral cup placement
- Inferior/Superior cup placement
- Flange and screw hole placement

Currently our Implant device utilizes the default locking mechanism. This utilizes the custom matched handle and liner extracting instrument.

If there are any questions, please feel free to contact me (email and phone listed above).

Implant features approved? (yes/no) If no, specify changes:

Anterersion yes no
 Abduction yes no
 Medial/Lateral cup placement yes no
 Inferior/Superior cup placement yes no
 Flange and screw hole placement yes no

Do you require coatings on the patient's implant? Yes No (this process will add 40 business days to the manufacturing time)

Comments or Changes

Establishing the ISO PDF Umbrella



PDF 1.7 (ISO-32000)

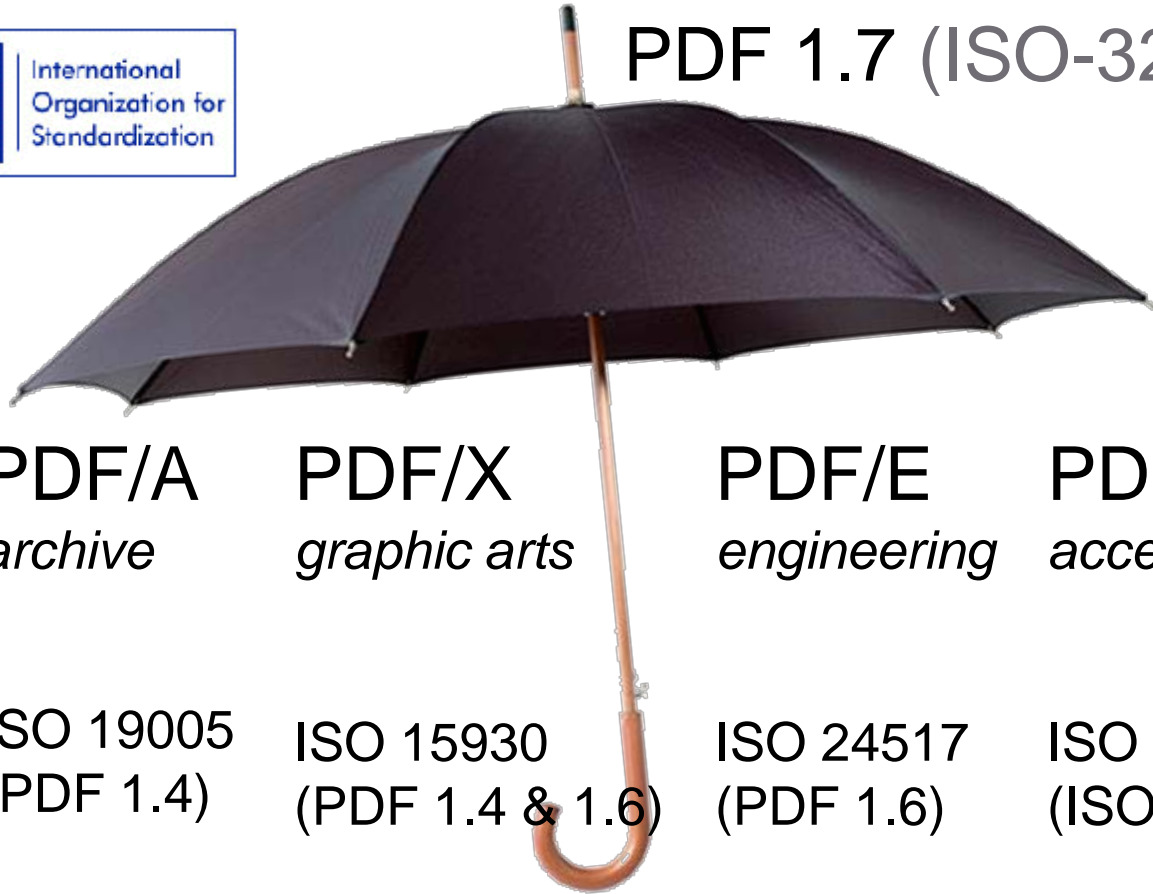

PDF/A
archive

PDF/X
graphic arts

PDF/E
engineering

PDF/UA
accessibility

ISO 19005
(PDF 1.4)

ISO 15930
(PDF 1.4 & 1.6)

ISO 24517
(PDF 1.6)

ISO 14289
(ISO 32000)

What is PDF/A?

- A file format for the “Long Term Electronic Preservation” of multi-page documents that may contain a mixture of text, raster images and vector graphics
- PDF/A: 1– ISO 19005
 - Published in 2005
- Long-term really means *LONG*
 - Nuclear industry = 1000s of years



Preservability – Format Comparison

	Fidelity, presentation & reliability	Access to content & searching	Dependencies – platform, application, OS	Access to specifications	File Size
PDF	✓	✓	✓	✓	✓
Image: TIFF, JPEG, BMP	✓	✗	✓	?	✗
Native Formats: doc, office	?	?	✗	?	?
HTML	✗	?	✗	✓	✗
XML*	?	✓	?	?	?

PDF/A – PDF for Archiving

- **ISO PDF/A 19005-1 - Published October 2005**

- Open file format based on PDF 1.4
- Standard defines what is required, recommended & prohibited
- For more information visit: http://www.aiim.org/pdf_a

- ✓ An archival replacement for paper
- ✓ Customized to offer consistent, long-term retrieval and rendering
- ✓ Includes document metadata (XMP) for search and retrieval
- ✓ Engineered for reliable migration and future compatibility
- ✓ Digital signatures are for verification and not authentication
- ✓ Developed and maintained by PDF/A ISO committee

PDF/A Restrictions:

- ☒ No encryption
- ☒ No multimedia
- ☒ All data must be self-contained
- ☒ No proprietary fonts
- ☒ No JavaScript

PDF/A is **one** component of a comprehensive archiving strategy

Two “Levels”

- Minimal Conformance (PDF/A-1B)
 - Meet the standard/basic requirements
- Full Conformance (PDF/A-1A)
 - Tagged PDF
 - Improved searchability via Unicode mappings
 - Comprehensive metadata requirements
 - Font data
 - Document “pedigree”
 - Audit trail

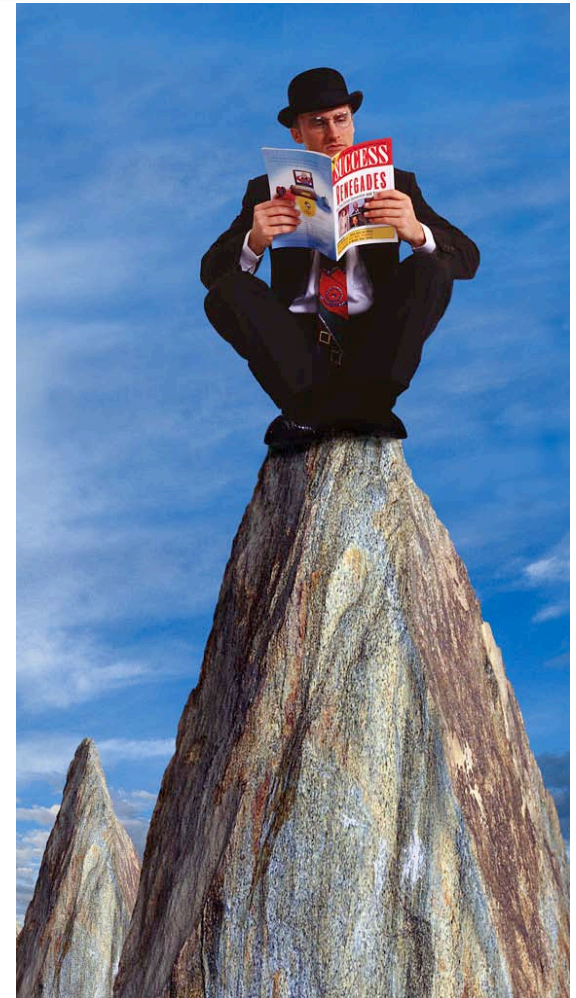

What is PDF/E?

- Addresses need for reliable exchange of engineering documentation
 - Secure distribution of intellectual property
 - Reliable exchange and change management
 - Reduces costs associated with proprietary viewers and formats as well as paper
- Covers 3 primary areas:
 1. Incorporation of complex data into compact PDF (3D, object-level data, etc.)
 2. Accurate printing of engineering drawings
 3. Support for secure exchange/management of annotation and comment data
- Constrained appearance to provide predictability
 - ✓ All fonts MUST be embedded
 - ✓ No external resources: self-contained
 - ✓ Layers, 3D, multimedia

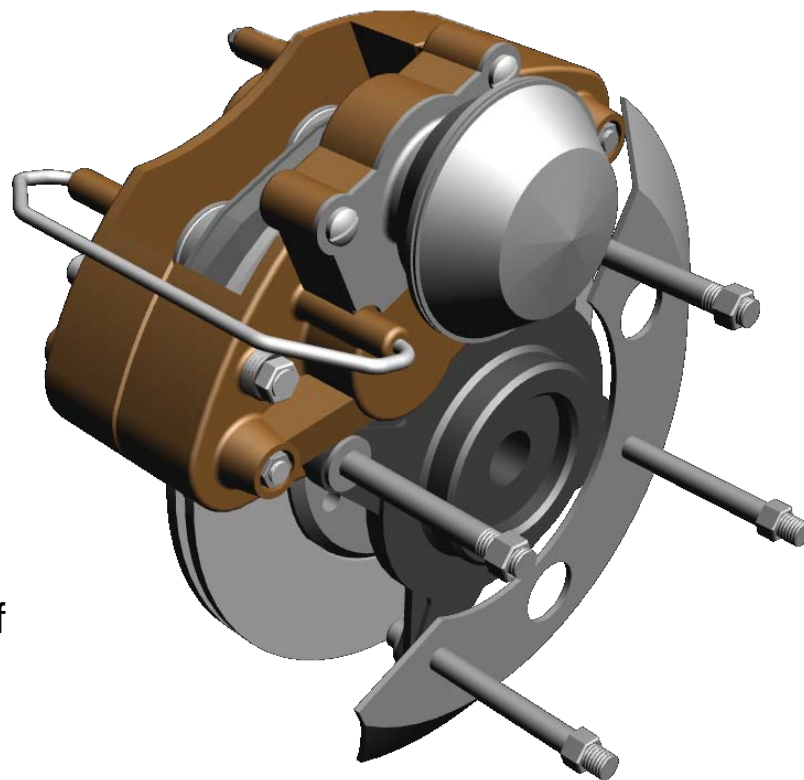

PDF/E-1 published as an ISO standard (6.2008)

- **In process: ISO 14289 - PDF/UA**

- Standard defining necessary elements for PDF files to be accessible to individuals with disabilities
- For more information visit: <http://www.aiim.org/standards>

- ✓ Definition of accessible PDF documents
- ✓ Specifies required elements for specific instances of PDF documents – i.e., tables, forms, fonts
- ✓ Includes participants from government, education & private sector
- ✓ Developed and maintained by ISO PDF/UA working group



PDF becomes an ISO Standard

- *“SAN JOSE, Calif. — **Jan. 29, 2007** — Adobe Systems Incorporated (Nasdaq:ADBE) today announced that it intends to release the full Portable Document Format (PDF) 1.7 specification to AIIIM, the Enterprise Content Management Association, for the purpose of publication by the International Organization for Standardization (ISO).”*
- Establish a baseline standard
 - cover the millions of PDF files that already exist
 - describe the behavior of existing ‘defacto standard’ viewers
- Evolution of PDF specification as a public and open activity
 - ISO is widely recognized and respected & experienced with PDF-based standards
 - Adobe is just one of many participants in the working group
- **ISO 32000-1 was ratified in January 2008! (published 5/2008)**



Establishing the ISO PDF Umbrella



PDF 1.7 (ISO-32000)

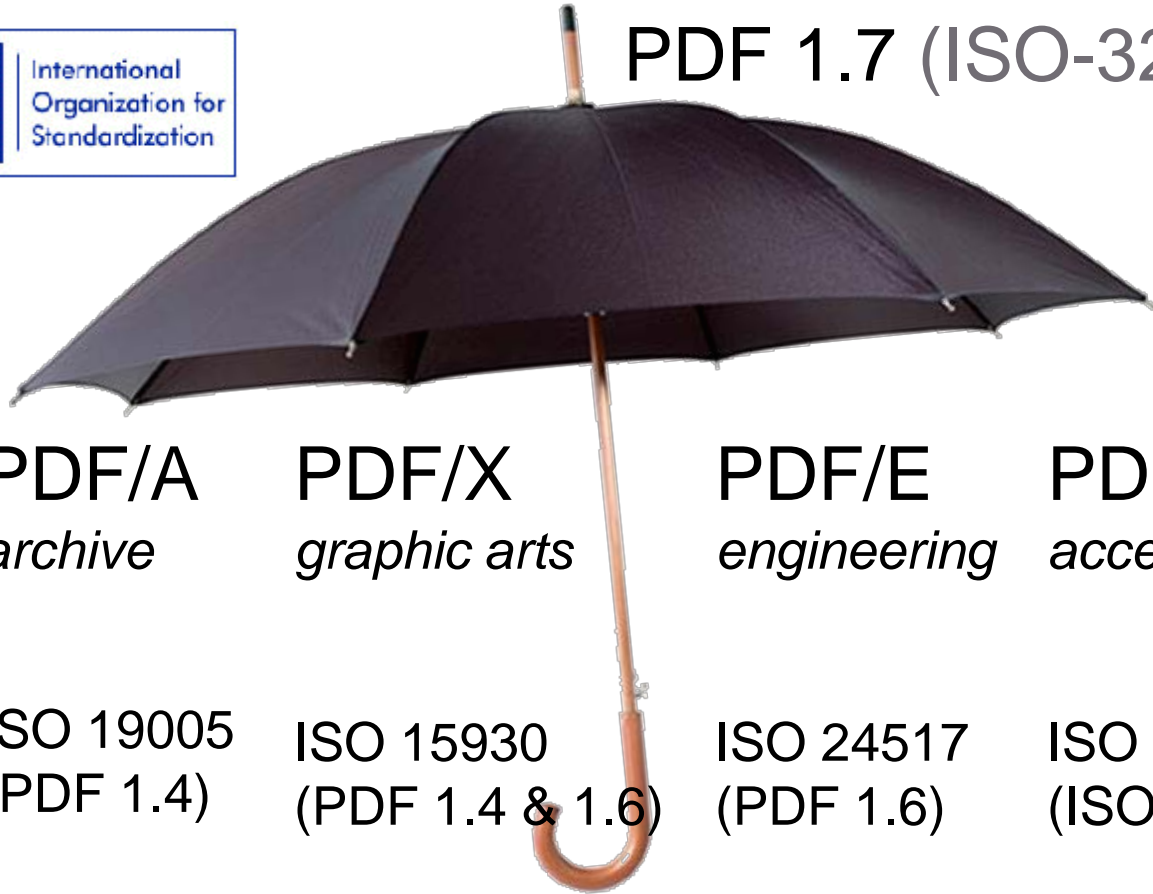

PDF/A
archive

PDF/X
graphic arts

PDF/E
engineering

PDF/UA
accessibility

ISO 19005
(PDF 1.4)

ISO 15930
(PDF 1.4 & 1.6)

ISO 24517
(PDF 1.6)

ISO 14289
(ISO 32000)

Other Standards Activities Related to PDF

- PDF for Healthcare is a Best Practices Guide standardized and published by AIIM/ASTM: www.aiim.org/pdfh

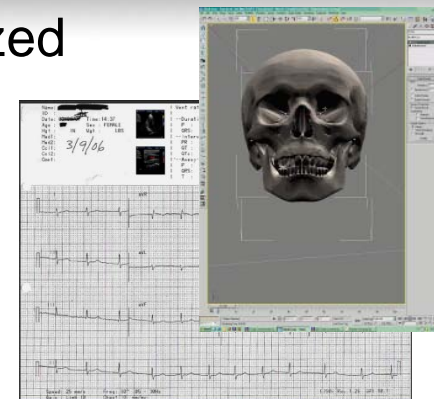

▪ Metadata - XMP

- Currently an Adobe open specification
- Adopted by industry
- Currently exploring harvesting by a standards development organization



▪ 3D - U3D/PRC

- U3D v3 is currently an ECMA standard for 3D content
- PRC is under development as an ISO standard for 3D content: ISO 14739

▪ PDF can contain structured and unstructured content which can be viewed by the free Adobe Reader

- Structured content authoring can produce a tagged PDF based on XML

PDF's Ecosystem and the Path to Standardization

- 15 Years of Learning and Ecosystem Building
- 1993 PDF 1.0 Designed for office documents
- 1997 PDF 1.2 Fill-in forms & prepress features introduced
- 2001 PDF/X Open, ISO standard just for publishing exchange
- 2001 PDF 1.4 Features for Microsoft Office & the Internet
- 2005 PDF/A Open, ISO standard for archiving
- 2003 PDF 1.6 3D introduced for engineering drawings
- 2007 PDF/E Open, ISO standard for engineering document exchange
- 2008 ISO 32000 Open, ISO standard for PDF (PDF 1.7)

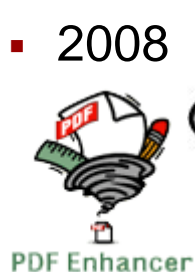

The Pros and Cons

- A successful standard is one which:
 - Meets a need
 - Continues to be maintained
 - Gets referenced by other standards
 - Is easily accessible by all who need to use it
 - Eases interoperability
- What prevents standards from being used or widely adopted?
 - Lack of need, consensus
 - When there's a barrier to entry
 - Cost



PDF Uniquely Positioned

- Many paths lead to standards creation
 - Standards support many industries, particularly those that are regulated
 - Well-formed standards are long-lasting, have low barriers to entry, and are often referenced by other standards
- PDF support is ubiquitous **and** PDF is an international (ISO) standard
 - Billions of existing files
 - Thousands of software products, including open source
 - Provides broader functionality than any other document format
 - Established strongly in publishing, archiving, engineering, and other industries
- PDF is distinctly separate and complementary to both ODF and OOXML
 - PDF completes the lifecycle for documents authored using ODF or OOXML

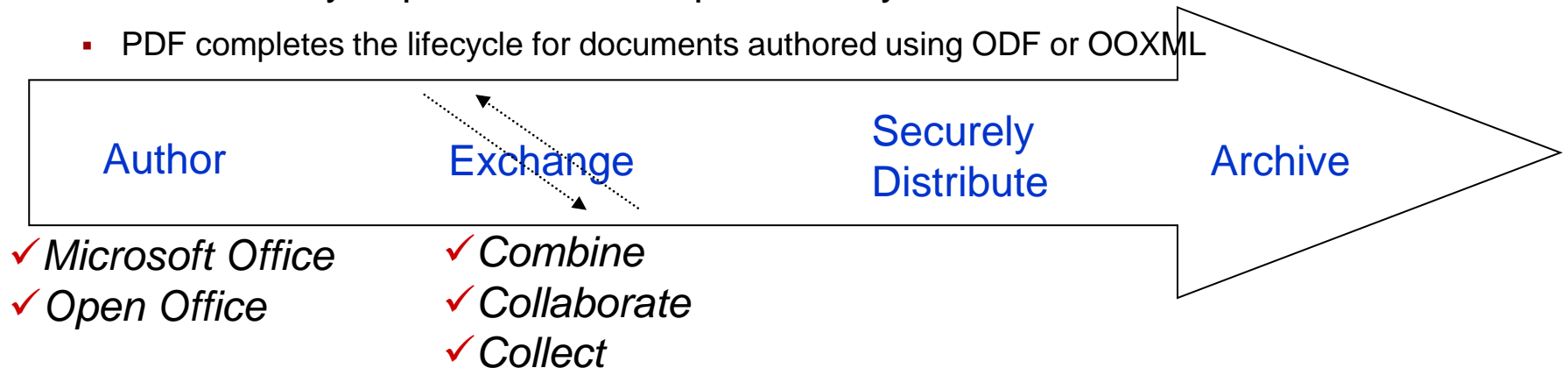



Adobe

sangiah@adobe.com